



# NEW HOLLAND ROLL BALER

Roll Baler 125 | Roll Baler 125 Combi | Roll Baler 135 Ultra



## NEW ROLL BALER. HIGH QUALITY IN LARGE QUANTITY.



At New Holland we listen to our customers. The latest fixed chamber Roll Baler 125, Roll Baler 125 Combi and Roll Baler 135 Ultra are built to meet the demands of both livestock farm and contract users operating in challenging conditions. Combining rugged build with high performance and low whole life operating costs, the Roll Baler range is built tough to keep you ahead. The three-model range covers every base. For producing top quality grass and straw bales quickly and efficiently, the 1.25m diameter Roll Baler 125 is the discerning choice. For professional users who value the benefits of baling and wrapping with one machine, then the Roll Baler Combi is the way to go. Need greater output, more sophisticated controls and a larger 1.35m bale? Then the Roll Baler Ultra 135 has the extra features to suit the most demanding user – but without complexity.



### NEW HOLLAND: OVER 35 YEARS OF ROUND BALER INNOVATION

- 1974:** New Holland's first round baler - the Model 850 chain 5'x 6' baler
- 1989:** Model 630 - introduction of the Roll-Belt™ round baler
- 1991:** Models 650/660 Roll-Belt™ Variable chamber round balers
- 1995:** Model 664 Silage Special with Bale-Slice™ feature
- 1997:** Model 544 - first European built roll bar baler
- 2002:** BR700 Series Roll-Belt™ round balers including the new BR740 CropCutter™ model
- 2003:** Model 548 Combi - first New Holland baler/wrapper combination
- 2004:** BR6000 series - featuring unique Duckbill edge wrap system
- 2007:** BR7000 series - Roll belt balers
- 2012:** New Roll Baler heavy duty fixed chamber round balers



 **SUPERIOR EFFICIENCY**

Follow the driveline from the tractor PTO and through the gearbox and then to the rollers and pick-up. Simple, direct and efficient, the entire driveline combines low maintenance with high efficiency. More baling efficiency and lower fuel consumption meets reduced maintenance and improved longevity.

 **BALE QUALITY**

The 20 crop processing knives can be raised or lowered to suit every type of bale, different crops and straw as well as conditions. The rollers are profiled to ensure incoming material is rolled as soon as it enters the chamber for consistently dense and uniformly shaped bales of hay, haylage, silage or straw. Versatile baling comes as standard.

 **ABSOLUTE BALING PLEASURE**

Difficult slopes and undulating land? No problem with a New Holland Roll Baler. A wide track and heavy duty axles equipped with large, low ground pressure tyres, enable these balers to maintain a low centre of gravity for stability in demanding terrain. Combi and Ultra models have tandem axles and braking to all four wheels. On-slope security comes as standard

 **OUTSTANDING DURABILITY**

Robust lubricated sleeve bearings support the chamber rollers. Tolerant of high loads and acid additives, the sleeve bearings are automatically greased to reduce downtime. All key drive chains are oiled every time the chamber door is opened. Hardox steel reduces wear. Durability comes as standard.



2002



2003



2004



2007



2012

## PRODUCTIVITY BEGINS AT THE PICK-UP

New Holland Roll Balers are fitted with a wide, five tine bar pick-up, purpose developed, to handle large and heavy grass swaths over difficult terrain. This optimises performance in difficult conditions. The full-width feed rotor ensures material is actively fed into the bale chamber for high productivity in all conditions. The static crop processing knives can be raised or lowered to suit demands. When baling straw, all models have the capacity to deal with the large swaths left by wide header combines, ensuring the production of a dense and consistent straw bale even in extremely dry conditions.



### WIDER PICK-UP BOOST VERSATILITY AND PERFORMANCE

Roll Baler 125 and 125 Combi models have a 2.1m pick-up, The Roll Baler 135 Ultra features a wider 2.2m pick-up of the same five-tine bar design. Fitted with 16 and 18 tines per row respectively, the pick-ups offer exceptional crop clearance when handling both light and dense, heavy swaths.

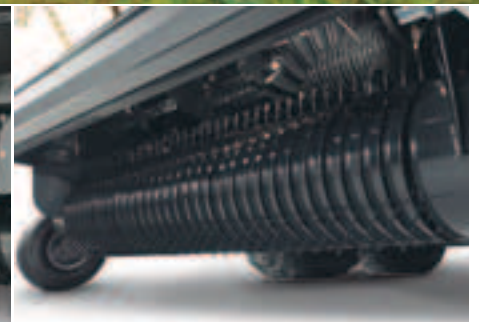

### WINDGUARD HANDLES LARGE, DENSE SWATHS

The windguard roller ensures large, high volume swaths are presented to the lower part of feed rotor. This helps to ensure an even feed of material at all forward speeds for consistent bale formation in all conditions. The windguard also helps ensure the operator has a good view of the intake.

### FIVE TINE BARS FOR A CLEAN SWEEP

Conventional baler pick-ups have long relied upon a four-tine bar design. This is perfectly adequate for 'average' grass and straw swaths. High capacity Roll Balers are fitted with an extra tine bar to enhance the clearance of both dense and lighter swaths at higher forward speeds. The 2.1m pick-up has 80 pick tines, the wider 2.2m width of the Roll Baler 135 Ultra having 90.



### TOOL FREE PICK-UP WHEEL ADJUSTMENT

Setting the pick-up wheel height is quick and easily replicated on both sides. Using a robust, simple and tool-free clip and hole system, the height setting can be quickly altered to match changing ground conditions and crop densities.

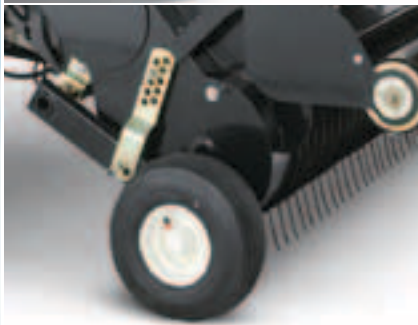

### SLIP CLUTCH PROTECTION IN HEAVY CROPS

In addition to the unit in the PTO shaft, a further slip-clutch is fitted in the pick-up and rotor feed drive. This provides extra protection to the baler when working in really demanding conditions.



### BLOCKAGE IN TOUGH GOING? NO PROBLEM!

On 125 and 125 Combi models, if a blockage occurs, the drive to the rotor and pick-up can be hydraulically disengaged from the tractor seat. This allows the operator to continue to drive the rolls, to wrap and eject a bale. Re-engagement of the rotor and pick-up usually clears the problem. A useful crank handle is provided if manual reversal of the feed rotor is necessary.

On 135 Ultra models, a hydraulic feed reverser system is fitted and controlled from the in-cab bale monitor. When selected, the knives are automatically lowered and drive to the pick-up and feed rotor is reversed. This allows blockages to be cleared without the operator leaving the cab.

### HARDOX STEEL FEED ROTOR

Hardox 500 steel is tough and wear resistant. By using it to make the 470mm diameter feed rotor and 10mm thick tines, New Holland ensures all Roll Baler models will offer dependable performance season after season. With New Holland Roll Balers, reduced operating costs come as standard.

### ROTOR DESIGN DELIVERS CONSISTENT CROP FLOW

New Holland has unrivalled experience in the design of high capacity balers. The feed rotor tines are positioned around the rotor in a 'W' pattern. Proven on BigBalers, this design enhances the flow of material into the bale chamber and reduces strain on the driveline.

### CROPCUTTER™ SLICES WITH EASY EFFICIENCY

All three Roll Baler models are fitted with the New Holland CropCutter system. The feed roller draws in-coming material over a bank of 20 retractable chrome vanadium blades. The operator can choose to either work the baler with the knives raised or lowered. The number of knives can also be reduced to suit individual requirements. Each knife has overload protection.

### KNIVES OUT

As an option, the position of the CropCutter knives can be displayed on the bale monitor. On the Roll Baler 135 Ultra, the knives can be raised or lowered via the control box.



## DENSE BALES THAT STAY THAT WAY

New Holland Roll Balers combine ease of operation and low maintenance with excellent productivity. Key features include the production of high-density bales that can be secured using a choice of net or, on Combi and Ultra models, film wrap. Dense bale packaging and tight wrapping ensures the bales retain their shape for ease of handling and storage.



### BIG ROLLERS ROLL THE DENSEST BALES

The 200mm diameter bale chamber rollers have four aggressive profiles designed to ensure full crop contact as the bale is formed. By ensuring material within the chamber is rolled from the instant it enters the chamber, the density of the bale is guaranteed.



### BUILT TOUGH FOR LONG TERM DEPENDABILITY

Each of the 18 bale chamber rollers run on easily replaced lubricated sleeve bearings. Offering a high contact area, these sleeve bearings are automatically lubricated and offer a service life of tens of thousands of bales. The sleeve bearings are also tolerant of bale treatment additives to include inoculants and acids.



### SIMPLE BUT RELIABLE WRAPPING

A great deal of effort has gone into the design of the net wrap system. This is to ensure the system is not only reliable and simple to set up, but also produces an extremely tight wrap. This is important in securing the densely packed bale. Both Combi and Ultra models have the capacity to carry two spare rolls of net.



## DENSE BALES MAKE BETTER HAYLAGE AND SILAGE

Due to the high strength of the bale chamber and the aggressive profile of the rollers, more material can be packed into the balers to produce a really tight and dense fill. This helps exclude oxygen and promote the anaerobic fermentation needed to produce the best silage or haylage. Roll Baler 135 Ultra models has an active density control system, that allows the operator to select a denser bale to suit certain requirements.

## NET WRAP FOR HAY AND STRAW

Net wrapping remains a standard fit on all Roll Baler models. Uncomplicated, simple to adjust, easy to set up and well proven, net wrapping remains the top choice for hay and straw baling.

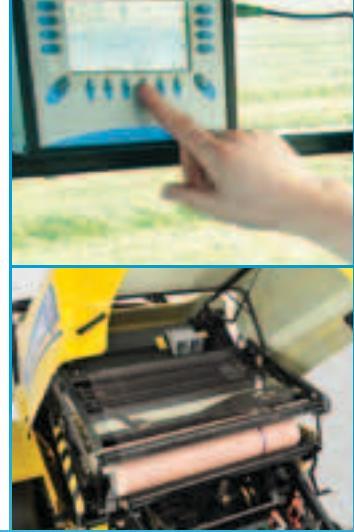

## DID YOU KNOW THAT?

Film-wrapping offers other benefits including an improved bale oxygen barrier. This facilitates the fermentation process for higher quality forage. Studies show that film wrapped bales are, on average, measurably tighter than those wrapped in net.



## FILM WRAP OPTION REDUCES COSTS AND PRODUCES A BETTER BALE

Both the Roll Baler 125 Combi and Roll Baler 135 Ultra can be specified with a film-wrap system that can be used in place of net wrapping for haylage and silage bales. Designed to work in conjunction with the integral wrapping system, using film wrap to secure the bale offers numerous benefits. These include:

- Bale shape. Film helps keep the bales really tight, by reducing bale expansion when exiting the chamber.
- Ease of unwrapping. Film does not catch on the bale and is easier to remove
- One material system. Uses the same material as employed by the wrapper.
- Higher quality silage. Peripheral film helps seal the bale more effectively than conventional wrapping alone.
- Lower wrapping cost. Fewer layers of stretch film are required to seal the wrapped bales.
- Film arm mechanism pre-stretches the film wrap before it is rolled around the periphery of the bale for consistent wrapping quality.



## ENGINEERED TO TAKE THE WORRY OUT OF WRAPPING

New Holland has continued to refine the in-line wrapping process it first used on its the 548 Combi back in 2003. Designed to allow freshly produced bales to be wrapped securely over difficult terrain and reliably in both cool and hot working conditions, the integral wrappers of both the Roll Baler 125 Combi and Roll Baler 135 Ultra are, thanks to their twin satellite arms, fast enough to allow any multiple of wraps required by the end user.



### ENGINEERED TO TAKE THE WORRY OUT OF WRAPPING

Tubular satellite arms carry the two 750mm film stretchers. Rotated via an infinitely adjustable hydraulic motor, the satellite arm speeds can be adjusted to allow between 40 to 50 (55 maximum for 135 Ultra) bales to be wrapped an hour, day in and day out, week after week. Fully automated, with a well-proven film cut knife system, the wrapping system can be monitored via an optional camera system. Film Pre-stretch can be set to up to 70%.





### ONE MACHINE DOES IT ALL

In-line baling and wrapping removes the need for a separate wrapping operation, saving on manpower and equipment. This also reduces bale production costs. Less cost to the farmer; better returns for the contractor.

### INCREASED HAYLAGE AND SILAGE QUALITY

Repeated studies have proven that a haylage or silage bale that is wrapped quickly will produce better quality forage with a reduced likelihood of spoilage. Bales that are wrapped are also less likely to suffer if left in the field for an extended period prior to collection and removal to their storage location.



### CARRY MORE STRETCH FILM FOR GREATER PRODUCTIVITY

Roll Baler 125 Combi and Roll Baler 135 Ultra models have the capacity to carry 8 and 6 rolls of spare stretch film respectively.



### ONE CONTROL DOES IT ALL

The in-cab bale controller has been developed to simplify the operation of the baler and, as applicable, the in-line wrapper. Providing the operator with information that includes density as well as the operation of the wrapper.

### GENTLY WRAPPED BALE HANDLING

To avoid damaging the finished bale, the wrapper discharge system tips the bale onto a handling mat that in turn allows the bale to gently roll from the rear of the unit. If necessary, the operator can retain the wrapped bale and discharge it away from steeply sloping terrain. A side tip function is offered for on-end bale discharge.



## LOW PROFILE FOR STABILITY AND ALL-ROUND VISIBILITY

New Holland appreciates that round baling is carried out in varying terrain. By ensuring all three Roll Baler models have a wide track and a low centre of gravity that is retained as the bale chamber fills, a tractor and Roll Baler combination is stable and secure on sloping ground. For added security, hydraulic brakes come as standard on all four wheels of the tandem axle 125 Combi and 135 Ultra models.

### NEW HOLLAND STYLE LOOKS GOOD AND IS PRACTICAL TOO

For over a decade, New Holland has developed a distinctive styling package for its tractors, combines, forage harvesters and balers. But the thinking behind this styling goes beyond good looks. Easy to clean, the rounded profile of the Roll Baler models also enables the operator to see more behind and to the sides of the baler. Great looking equipment is the New Holland standard.



#### ROLL BALER 125 – THE RIGHT TYRE FOR YOUR NEEDS

The single-axle Roll Baler 125 can be specified with a choice of 500/60x22.5 tyres for reduced surface damage and improved grass regrowth or smaller 400/60x15.5 tyres.



#### TANDEM AXLES SPREAD THE LOAD

To accommodate their extra weight and length, both the Roll Baler 125 Combi and Roll Baler 135 Ultra are fitted with tandem axles equipped with 500/50 R17 tyres.

## ENGINEERED TOUGH FROM THE OUTSET

New Holland developed the Roll Baler series specifically for the most demanding large livestock and contract users. Of equal importance, these rugged balers are designed to operate in a wide range of conditions. This includes working with heavy grass, dense hay and forage crops plus large dry, brittle straw swaths. Getting the balers ready for work takes less time thanks to fully automated lubrication for the baler chains and rollers. Simply check the lube levels, grease the PTO, load your film and net and away you go.



### HIGH STRENGTH CHASSIS

Each of the three Roll Baler models runs on a purpose designed chassis designed to carry exceptionally heavy bales over rough terrain. The way in which the pick-up, bale chamber and, on the Combi and Ultra models, the wrapper fit the chassis, has been carefully engineered so that load stress is distributed through the frame and not through the working components of the baler.

### HEAVY-DUTY SPROCKETS AND CHAINS

The driveline of New Holland Roll Balers has been tested in the most extreme working conditions to ensure it is dependable, efficient and durable. The combined use of heavy-duty chains and sprockets is matched to careful design. This improves driveline efficiency and reduces excess stress on those components that are subject to the highest loads in work.

### AUTOMATIC GREASING AND CHAIN OILING

Centralised, electronically controlled greasing guarantees that the rollers are fed lubricant during work. This ensures that even the hardest working lower rolls have a working life of tens of thousands of bales. The chain oiling system does not require the use of a special lubricant. To minimise oil consumption, the chains are lubricated only when the bale chamber tailgate is opened.

### DURABLE LUBRICATED SLEEVE BEARINGS

New Holland uses proven sleeve bearings to support the chamber rollers. These offer a number of advantages over conventional roller bearings that include longevity, high tolerance of contaminants, ease of replacement and low operating costs. The sleeve bearing to roll shaft area is increased to provide the exceptional strength necessary to support large, heavy bales. When the sleeve bearing needs replacing, it is a simple and economical operation.

### MAIN GEARBOX HAS CENTRAL DRIVE

Rigidly mounted in the centre of the baler, the gearbox is perfectly aligned with the driveline to minimise power loss and component stress. Power flow monitoring from the design stage through to production, ensures parasitic losses are minimised to optimise efficiency, reduce wear and cut fuel consumption. Designed for 540 and 540E PTO speeds or 1,000rpm PTO as an option.

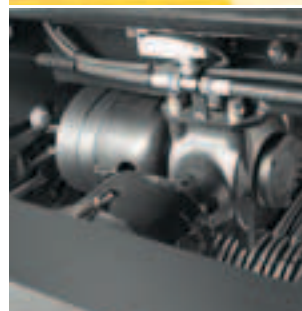
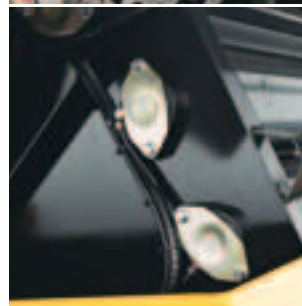

# RUGGED AFFORDABLE BALERS FOR LIVESTOCK FARMER AND CONTRACTOR USE

New Holland developed the Roll Baler 125 and Roll Baler 125 Combi to match the needs of those operating in predominantly livestock areas. The Roll Baler 125 is an impressively durable and rugged round baler that is easy to operate, has low maintenance demands and is well suited to producing dense bales in grass for hay or, when separately wrapped, haylage or silage. It is the ideal machine for larger scale intensive livestock farmers with excellent performance in all types of cereal straw.

The Roll Baler 125 Combi adds an integral bale wrapper and is designed to make it faster and easier to produce wrapped silage and haylage bales in small fields and in difficult terrain. Rugged and reliable, both the Roll Baler 125 and Roll Baler 125 Combi are built tough to work tough and meet the demands of larger scale livestock and contracting businesses, with low whole life operating costs.



## KEY FEATURES AT A GLANCE:

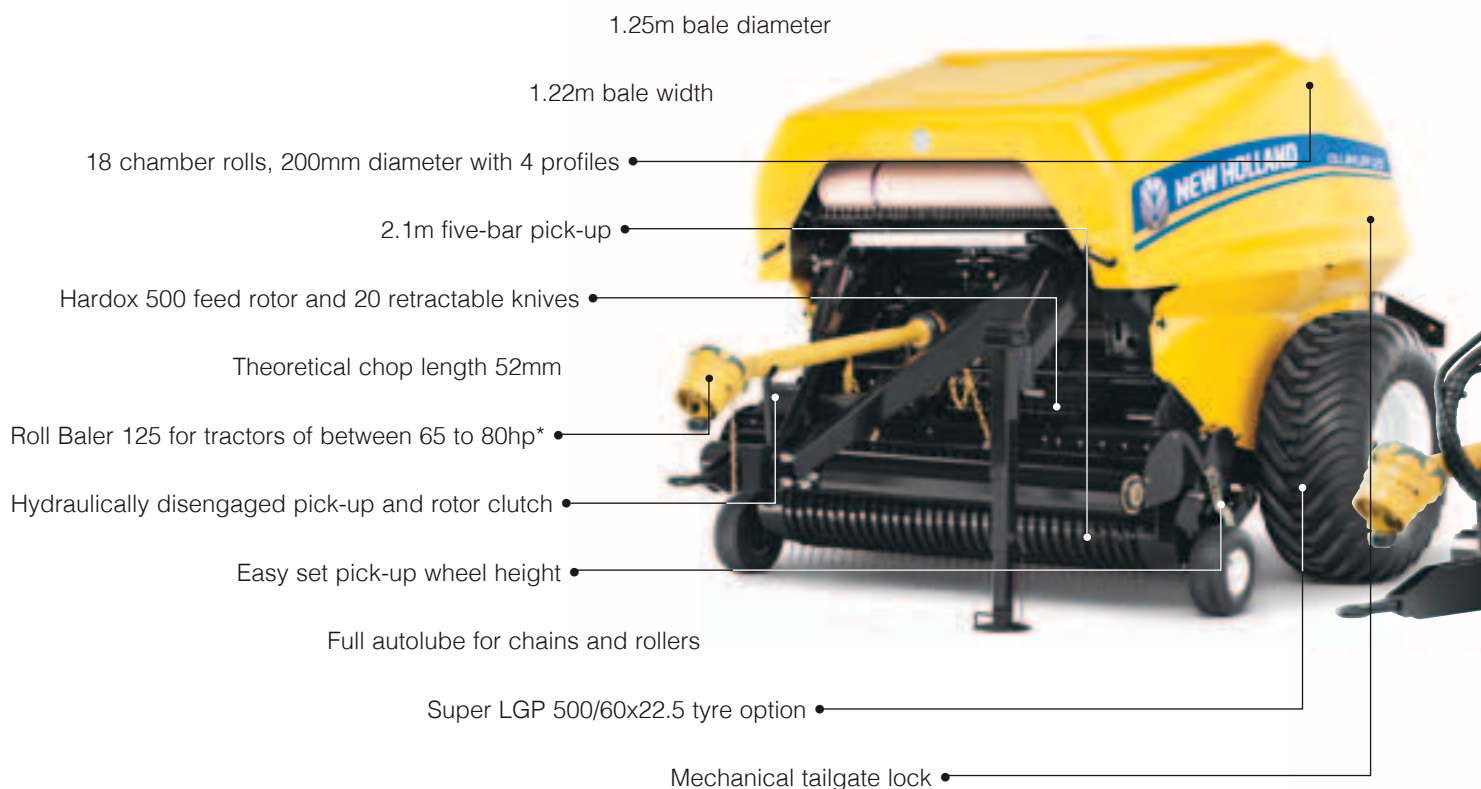



• Roll Baler 125 Combi for tractors of between 105 to 115hp\*

User friendly bale monitor

Electronic control of net wrap system

Crank handle to reverse feed roll if there is a blockage

• Fender mounted tool storage

• Spare Film/Net roll capacity 2

• Stretch film roll capacity 4+4

Advanced film-wrap option on 125 Combi

• Super LGP 500/50 R17 tyres

\*Tractor power guide only. Will be influenced by terrain and conditions

## PURPOSE DEVELOPED FOR THE MOST DEMANDING USERS

New Holland has developed the Roll Baler 135 Ultra to suit large livestock and contractor operators who also bale large quantities of straw. Key differences over the Roll Baler 125 include bale diameter settings between 120 - 135cm, bale density adjustment and up to 15% higher density than achieved by the 125, a narrower 2.75m transport width, a more advanced bale control system and a wider 2.2m pick-up.

Film-wrap is a key advance as the same material is used to secure and wrap the bale. Overall film use is reduced and sealing is improved for optimised anaerobic fermentation.



**KEY FEATURES AT A GLANCE:**

Bale diameter between 120 and 135cm with choice of bale densities

1.22m bale width  
2.2m five-bar pick-up

Theoretical chop length 52mm

Advanced bale controller

18 chamber rolls, 200mm diameter with 4 profiles

Advanced film-wrap option. Saves film and wrapping costs

Hydraulic tailgate lock

Electro-hydraulic net/film wrap system



Net/ film roll capacity 2/3

Full autolube system for chains and rollers

Roll Baler 135 Ultra for tractors of between 135 and 150hp\*

Wide opening panels for full service access

Hardox feed rotor and 20 retractable knives

Stretch film capacity 3+3

Rotor and pick-up reversal controlled from inside the tractor cab

Tool free easy set pick-up wheel height

In-cab selection of feed rotor reverse if there is a blockage

Easy loading wrap storage system

\*Tractor power guide only. Will be influenced by terrain and conditions

# NEW HOLLAND MAKES IT EASIER FOR YOU TO REDUCE YOUR OPERATING COSTS

Down time is the enemy of productivity. New Holland has worked hard to ensure all Roll Baler models are easy to set up, straightforward to drive and have simple servicing requirements. The fine details have been carefully considered. Loading full rolls of net wrap and film is simple, with sealed storage to help keep the operator clean when swapping rolls. Daily greasing and routine checks are easy to remember and simple to carry out. The automatic lubrication system does its job reliably and is easy to top up and check. With New Holland Roll Balers, you spend more time working.



## GREAT LOOKS ARE PRACTICAL TOO

The stylish side panels on all models lift on gas struts to provide easy service access. The panels help reduce debris build up, making it easier to check the balers both before and during work. Convenient tool storage is also a feature on the two larger models in the range.

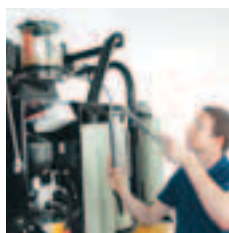

## CENTRALISED GREASING IS EASY TO CHECK

Easy to check and top up with grease, the centralised greasing system is extremely efficient too. The sleeve bearings are fed a carefully metered amount of grease to ensure prolonged operating life of tens of thousands of bales, on even the hardest working lower rolls. The bearings are easy and economical to replace.



## TAILGATE LOCK FOR YOUR SAFETY

To prevent the baler chamber tailgate closing during servicing, both 125 models are fitted with a ram stop, the 135 featuring a ram-locking tap. Ease of service is a key New Holland feature. The net and film roll storage points are positioned so they are low and easy to access. Fitting new rolls is made as easy as possible to reduce downtime.



## ONLY ADDS OIL AS IT IS NEEDED

Designed to use universal 10-40 oil, the chain oiling system feeds lubricant to the distribution brushes only when the baler tailgate is opened. This minimises oil consumption without any compromise in efficiency. Heavy-duty chains are fitted to all Roll Baler models as standard.



# BEYOND THE PRODUCT

## TRAINED TO GIVE YOU THE BEST SUPPORT

Your dedicated New Holland dealer technicians receive regular training updates. These are carried out both through on-line courses as well as intensive practical field based courses.

This advanced approach ensures your dealer will always have access to the skills needed to look after the latest and most advanced New Holland products.

## UNLIMITED SUPPORT FOR UNLIMITED SATISFACTION

New Holland gives you all the support you need, especially during the season with fast-track solutions: because your harvest can't wait! In addition, New Holland drives and tracks the solution you need, keeping you informed: until you are 100% satisfied!



**DO NOT RISK YOUR MACHINE'S LIFE.  
ALWAYS CHOOSE CNH INDUSTRIAL  
GENUINE PARTS!**



# THE WIDEST RANGE FROM THE BALING EXPERTS

New Holland has a long and illustrious baling heritage which stretches right back to the very beginning of baling itself. Over more than seven decades of continuous evolution, countless innovations which have revolutionised baling efficiency, productivity and comfort have been introduced which today, make New Holland the worldwide leader in baling technology.



## PIONEERING SPIRIT THAT CONTINUES TODAY

New Holland invented the very first self-tying pick up baler back in 1940. Today the BC5000 range of conventional balers continue to deliver the world's farmers dependable performance and traditional value. After all, since the small square baler was introduced some 900,000 units have been sold... and we're still counting.



## EXTENSIVE ROUND BALER OFFERING

The wide range of round balers are a hit amongst livestock and mixed farmers in the four corners of the globe. The BR6000 and BR7000 ranges of fixed and variable chamber balers offer outstanding productivity and dependable reliability.



## NEW BIGBALER. NO SPEED LIMIT

New Holland has led the big baler segment for over 25 years, introducing a string of pioneering firsts that have revolutionised big baling the world over. Owners will be spoilt for choice in terms of bale size, from 80x70cm through to the largest 120x90cm. Ultimate baling performance is guaranteed in all crops, both conventional and emerging crops. Hay and forage operations', straw contractors', biomass business' and large scale arable farmers' heads will be won over by up to a 20% capacity increase and up to 5% density improvement, whilst their hearts will beat a little faster when they see the elegant lines of this true harvesting professional.



MODEL		Roll Baler 125	Roll Baler 125 Combi	Roll Baler 135 Ultra
<b>Bale size</b>				
Bale diameter	(cm)	125	125	135
Bale width	(cm)	120	120	120
<b>Pick-up</b>				
Width	(cm)	210	210	220
Number of tines / tine bars		80/5	80/5	90/5
Windguard		roller	roller	roller
Number of pick up tines per row		16	16	18
Protection		slipclutch	slipclutch	slipclutch
Hydraulic pick-up lift		●	●	●
<b>Feeding</b>				
Type		rotor 470mm	rotor 470mm	rotor 470mm
Feeder disengagement		hydraulic	hydraulic	hydraulic
Number of augers		2	2	2
<b>CropCutter™ system</b>				
Number of knives		20	20	20
CropCutter™ engagement		hydraulic	hydraulic	bale monitor
Knife protection		spring	spring	spring
Rotor reverser		manual crank handle	manual crank handle	in-cab control
<b>Bale formation</b>				
Type		Profiled Roller system	Profiled Roller system	Profiled Roller system
Number of Rollers		18	18	18
Roller diameter	(mm)	200	200	200
<b>Wrapping</b>				
Wrap material		net only	net or film wrap	net or film wrap
Control		bale monitor	bale monitor	bale monitor
Spare roll capacity		1 active, 1 stored	1 active, 2 stored	1 active, 2 stored
<b>Silage wrapper</b>				
Film width	(mm)	–	750	750
Number of wrapping arms		–	2	2
Pre-stretch		–	70%, adjustable	70%, adjustable
Hydraulic system		–	single acting	single acting
Oil flow min / max	(litres/min)	–	30	50 / 55
<b>Baler dimensions</b>				
Length, incl. bale ejector	(m)	3.86	5.90	6.20
Height	(m)	2.15	2.65	2.80
Width with pick-up wheels	(m)	2.72 / 2.92	2.99	2.75
Weight	(kg)	2800	4500	4900
<b>Tyres</b>		400/60 R15.5, 500/60 R22.5	500/50 R17	500/50 R17
<b>Axles</b>		single	tandem	tandem
<b>Bale mat</b>		–	○	○
<b>Bale kicker</b>		●	–	–
<b>Bale turner</b>		–	○	○

● Standard    ○ Optional at extra cost    – Not available

# NEW HOLLAND. A REAL SPECIALIST IN YOUR AGRICULTURAL BUSINESS.



AT YOUR OWN DISTRIBUTOR



Visit our website: [www.newholland.com](http://www.newholland.com)  
Send us an e-mail: [africa.topservice@newholland.com](mailto:africa.topservice@newholland.com)  
[middleEast.topservice@newholland.com](mailto:middleEast.topservice@newholland.com)



The data indicated in this folder are approximate. The models described here can be subjected to modifications without any notice by the manufacturer. The drawings and photos may refer to equipment that is either optional or intended for other countries. Please apply to our Sales Network for any further information. Published by New Holland Brand Communications. Bts Adv. (Turin) - 04/15 - MEA5310N/INB

New Holland with



New Holland prefers **AMBRA** lubricants